

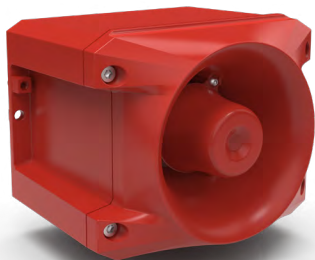







# PROTECT SOUNDER 116 dB(A) PRO 10 SIL



- Excellent robustness – Cast aluminium housing guarantees long lasting use in tough applications
- SIL 2/PL d – Fulfilling functional safety requirements by integrated safety design and diagnosis channel
- Selectable tone – 80 different tones, 3 additional tones externally selectable
- Selectable sound pressure – Reduction of sound pressure level up to 30 dB, internally or externally selectable
- Pre- & main alarm – Preventing shock reactions by pre-alarming due to reduced sound pressure level
- Safe & easy handling – Designed with unlosable seal and screws to significantly shorten wiring and installation times

											
acoustic penetration	protection system	impact-proof housing	operating temperature	warranty 10 Years	sound adjustable	SIL PL	pending	approval	protection system	ext. sound reduction	DC version, inrush current limitation

3D-COVERAGE PERFORMANCE DATA	PRO 10 SIL	
	<b>AUDIBLE</b> 80 dB (A)	51 x 49 x 24 m @ DIN tone
	85 dB (A)	29 x 27 x 14 m @ DIN tone
	90 dB (A)	16 x 15 x 8 m @ DIN tone

To determine the exact signalling area for your needs, please use the online available Pfannenberg Sizing Software PSS.

PRODUCT	PRO 10 SIL	
<b>DATA</b>		
Rated voltage	115 / 230 V AC	12 - 48 V DC
Rated frequency	50 / 60 Hz	
Operating range	95 - 265 V	10 - 60 V
Current consumption @ DIN tone	85 mA @ 230 V AC	355 mA @ 24 V DC
Current consumption (max)	95 mA @ 230 V AC	400 mA @ 24 V DC
Diagnostic channel	Current consumption	25 mA @ 230V AC
	Switching power	230 V / 80 mA
Sound pressure level @ DIN tone	114 dB(A) @ 1m	
Sound pressure level max.	116 dB(A) @ 1m	
Sound level reduction	-4 dB / -10 dB / -16 dB / -22 dB / -26 dB / -30 dB	
Alarm tones	80 / 3 ext. selectable	
Operating / storage temperature	-40 °C ... +55 °C / -40 °C ... +70 °C	
Duty cycle	100 %	
Degree of protection	IP66 / IP67 / NEMA 4/4x / IK09	
Material	Aluminum	
Clamping range of the cable fitting	7 - 13 mm	
Connecting terminals	stranded 2.5 mm <sup>2</sup> , solid 4.0 mm <sup>2</sup>	
Weight	2770 g	2720 g

## OPTIONS



approval

**DIMENSIONS**

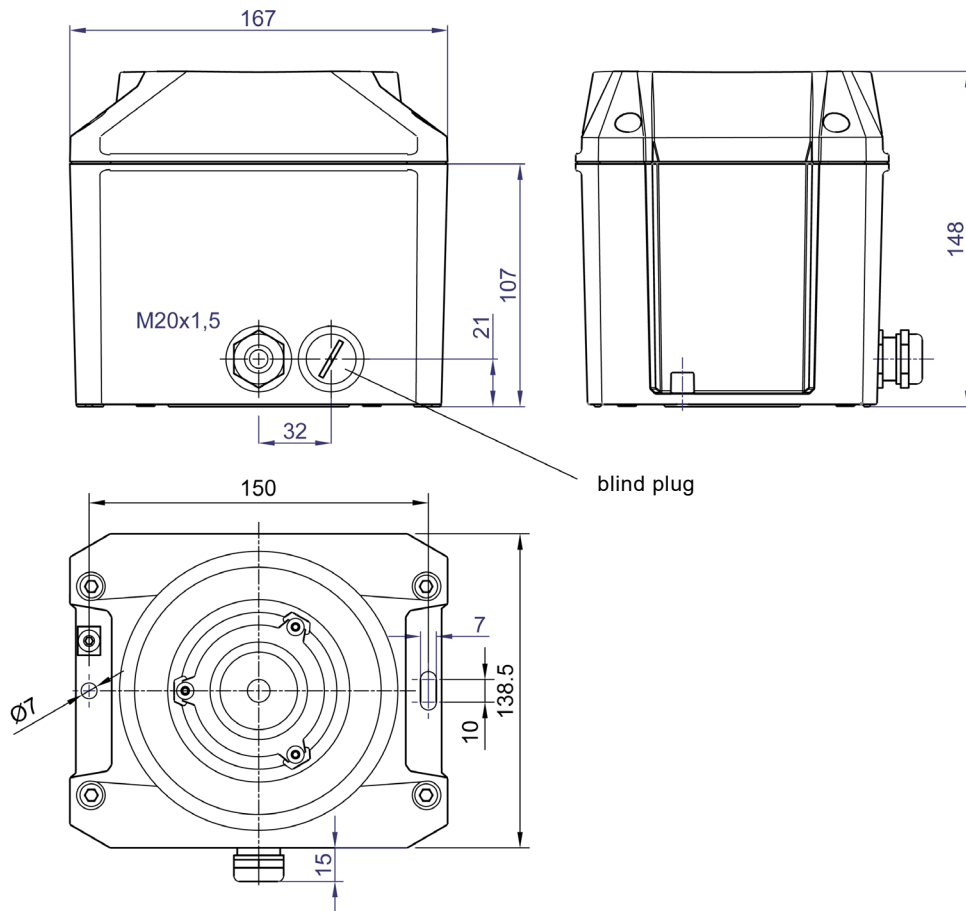

ARTICLE NO.	PRO 10 SIL	
VERSION	115 / 230 V AC	12 - 48 V DC
SIL	23150640601	23150630601

Article numbers for other voltages and versions on request.

TONE TABLE			
NO.	DESCRIPTION		
1	no tone		
2	Sawtooth, DIN tone 33404-3 Germany (emergency signal), PFEER PTAP	1200 Hz 500 Hz	
9	Slow whoop, fire alarm, UK BS5839-1	970 Hz 800 Hz	
11	Interrupted tone (fast)	970 Hz 800 Hz	
13	Interrupted tone	900 Hz 700 Hz	
15	Slow whoop, evacuation alarm Netherlands NEN 2575	1200 Hz 500 Hz	
16	Slow whoop, evacuation alarm Australia AS2220	1200 Hz 500 Hz	
18	Slow whoop, NFPA	775 Hz 422 Hz	
22	Pulsating tone, Australien alert AS1670, ISO8201	1200 Hz 500 Hz	
23	Siren	2400 Hz 500 Hz	
24	Siren	1200 Hz 300 Hz	
25	Siren	800 Hz 300 Hz	
26	Siren, industrial alarm Germany	1000 Hz 150 Hz	
27	Sweeping	2900 Hz 2400 Hz	
29	Sweeping (fast)	2900 Hz 2400 Hz	
30	Sweeping	2900 Hz 2400 Hz	
31	Sweeping, France NFC48-265	1600 Hz 1400 Hz	
33	Sweeping (medium), UK BS5839-1	1000 Hz 800 Hz	
34	Sweeping (fast)	1000 Hz 800 Hz	
35	Sweeping (fast), UK BS5839-1	1000 Hz 800 Hz	
36	Sweeping	1500 Hz 700 Hz	
43	Sweeping	1200 Hz 500 Hz	
44	Sweeping, IMO 3d, Germany KTA3901 evacuation alarm	1200 Hz 500 Hz	
45	Sweeping	1200 Hz 500 Hz	
46	Sweeping, general alarm Finland	1500 Hz 500 Hz	
52	Continuous tone	2400 Hz	
53	Continuous tone	2000 Hz	
54	Continuous tone, Finland (all-clear signal)	1500 Hz	
55	Continuous tone, PFEER gas alarm	1200 Hz	
56	Continuous tone	1000 Hz	
57	Continuous tone, UK BS5839-1	950 Hz	
59	Continuous tone	880 Hz	
60	Continuous tone	825 Hz	
61	Continuous tone	800 Hz	
63	Continuous tone	725 Hz	
65	Continuous tone, Sweden SS031711 (all-clear signal)	660 Hz	
66	Continuous tone	554 Hz	
67	Continuous tone, Germany KTA3901 (all-clear signal)	500 Hz	
68	Continuous tone	470 Hz	
69	Continuous tone	440 Hz	
71	Continuous tone	340 Hz	
77	Interrupted tone	2200 Hz	
82	Interrupted tone, PFEER (general alarm), UK BS5839-1 (back-up alarm)	1000 Hz	
83	Interrupted tone, PFEER (general alarm)	1000 Hz	
88	Interrupted tone	950 Hz	
90	Interrupted tone	825 Hz	
91	Interrupted tone	800 Hz	
92	Interrupted tone	800 Hz	
93	Interrupted tone (fast), Horn	800 Hz	
97	Interrupted tone	725 Hz	
98	Interrupted tone, Sweden SS031711 (emergency signal)	700 Hz	
100	Interrupted tone, industrial alarm Germany	680 Hz	
101	Interrupted tone, Sweden SS031711 (important message (pre-mess))	660 Hz	
102	Interrupted tone, Sweden SS031711 (local warning)	660 Hz	
103	Interrupted tone, Sweden SS031711 (air raid warning)	660 Hz	
104	Interrupted tone, Sweden SS031711 (emergency signal)	660 Hz	
107	Interrupted tone, Germany KTA3901 (evacuation alarm)	500 Hz	
109	Interrupted tone, Australia AS2220, AS1610, AS1670	420 Hz	
110	Interrupted tone, (fast variable), bell	1450 Hz	
111	Interrupted tone, ISO8201 (emergency evacuation signal), USA (evacuation alarm)	470 Hz	
112	Interrupted tone, ISO8201 (emergency evacuation signal)	950 Hz	
113	Interrupted tone, ISO8201 (emergency evacuation signal), sweeping	2850 Hz	

TONE TABLE			
NO.	DESCRIPTION		
115	Interrupted tone, IMO (telephone call)	950 Hz 	
116	Interrupted tone, IMO (leave ship)	950 Hz 	
117	Interrupted tone, IMO SOLAS III/50 + SOLAS III/6.4 (general alarm)	825 Hz 	
122	Alternating tone	2900 Hz 	
123	Alternating tone	2900 Hz 	
124	Alternating tone, Singapore	2900 Hz 	
125	Alternating tone	1400 Hz 	
128	Alternating tone	1025 Hz 	
130	Alternating tone, UK BS5839-1 (fire alarm)	1000 Hz 	
131	Alternating tone, UK BS5839-1 (fire alarm, railway crossing)	1000 Hz 	EN 54-3
135	Alternating tone, UK BS5839-1 (fire alarm, increased urgency – railway crossing)	1000 Hz 	
142	Alternating tone	900 Hz 	
143	Alternating tone, industrial alarm Germany	660 Hz 	
144	Alternating tone	650 Hz 	
146	Alternating tone, France NFS 32-001 (fire alarm)	554 Hz 	EN 54-3
147	Alternating tone, Sweden SS031711	554 Hz 	
148	Alternating tone, Sweden SS031711	554 Hz 	
152	Alternating tone (two tone chime)	800 Hz 	

### CONFORMITY TO STANDARDS

The acoustic parameters conform to the European standard DIN EN ISO 7731: "Ergonomic – alarms for public areas and workplaces – acoustic alarms".

The requirement for an acoustic alarm signal can be found in the harmonised standards:  
 EN 60204-1 Electrical equipment of machines  
 EN 60825-1 Radiation safety of laser devices, identical to IEC 825 and DIN-VDE 0837